

Operation Manual

Bently Nevada™ Asset Condition Monitoring

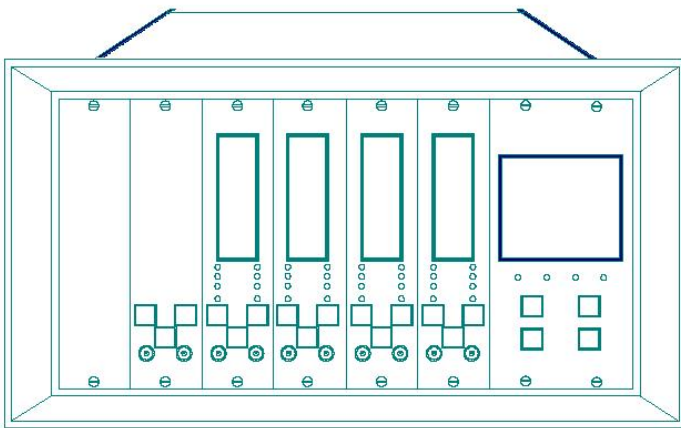

3300/03 System Monitor



imagination at work

Part Number 89604-01
Rev. F (08/07)

**Copyright © 1991. Bently Nevada LLC.
All rights reserved.**

The information contained in this document is subject to change without notice.

The following are trademarks of General Electric Company in the United States and other countries:

Dynamic Data Manager, Keyphasor, Proximitor and Transient Data Manager

Contact Information

The following ways of contacting Bently Nevada are provided for those times when you cannot contact your local representative:

Mailing Address	1631 Bently Parkway South Minden, Nevada USA 89423 USA
Telephone	1.775.782.3611 1.800.227.5514
Fax	1.775.215.2873
Internet	www.ge-energy.com/bently

Additional Information

Notice:

This manual does not contain all the information required to operate and maintain the product. Refer to the following manuals for other required information.

3300 System Overview (Part Number 80171-01)

3300 System Installation Instructions (Part Number 80172-01)

3300 System Troubleshooting (Part Number 80173-01)

3300/12 Power Supply (Part Number 89602-01)

Serial Data Interface & Dynamic Data Interface (Part Number 89541-01)

Dynamic Data Manager System (Part Number 46390-01)

Transient Data Manager User Guide (Part Number 79206-01)

Product Disposal Statement

Customers and third parties, who are not member states of the European Union, who are in control of the product at the end of its life or at the end of its use, are solely responsible for the proper disposal of the product. No person, firm, corporation, association or agency that is in control of product shall dispose of it in a manner that is in violation of any applicable federal, state, local or international law. Bently Nevada LLC is not responsible for the disposal of the product at the end of its life or at the end of its use.

SYMBOLS

Special symbols are used in the manual to illustrate specifics in the step-by-step processes. For example:



PRESS



FLASHING



CONNECT



DISCONNECT



OBSERVE



SCREWDRIVER



ALARM

Contents

1.	SYSTEM MONITOR	1
2.	MONITOR FUNCTIONS.....	2
3.	ASSEMBLY & DISASSEMBLY PROCEDURE.....	4
4.	DATA INTERFACE REMOVAL.....	5
5.	FRONT PANEL INSTALLATION & REMOVAL.....	6
6.	MONITOR OPTIONS.....	7
7.	PROGRAMMABLE OPTIONS	8
8.	OK RELAY CONFIGURATION.....	10
9.	OPERATIONAL TESTING.....	11
10.	Keyphasor OPERATIONAL TEST.....	12
11.	RECOMMENDED SPARE PARTS	17
12.	SPECIFICATIONS.....	18

1. SYSTEM MONITOR

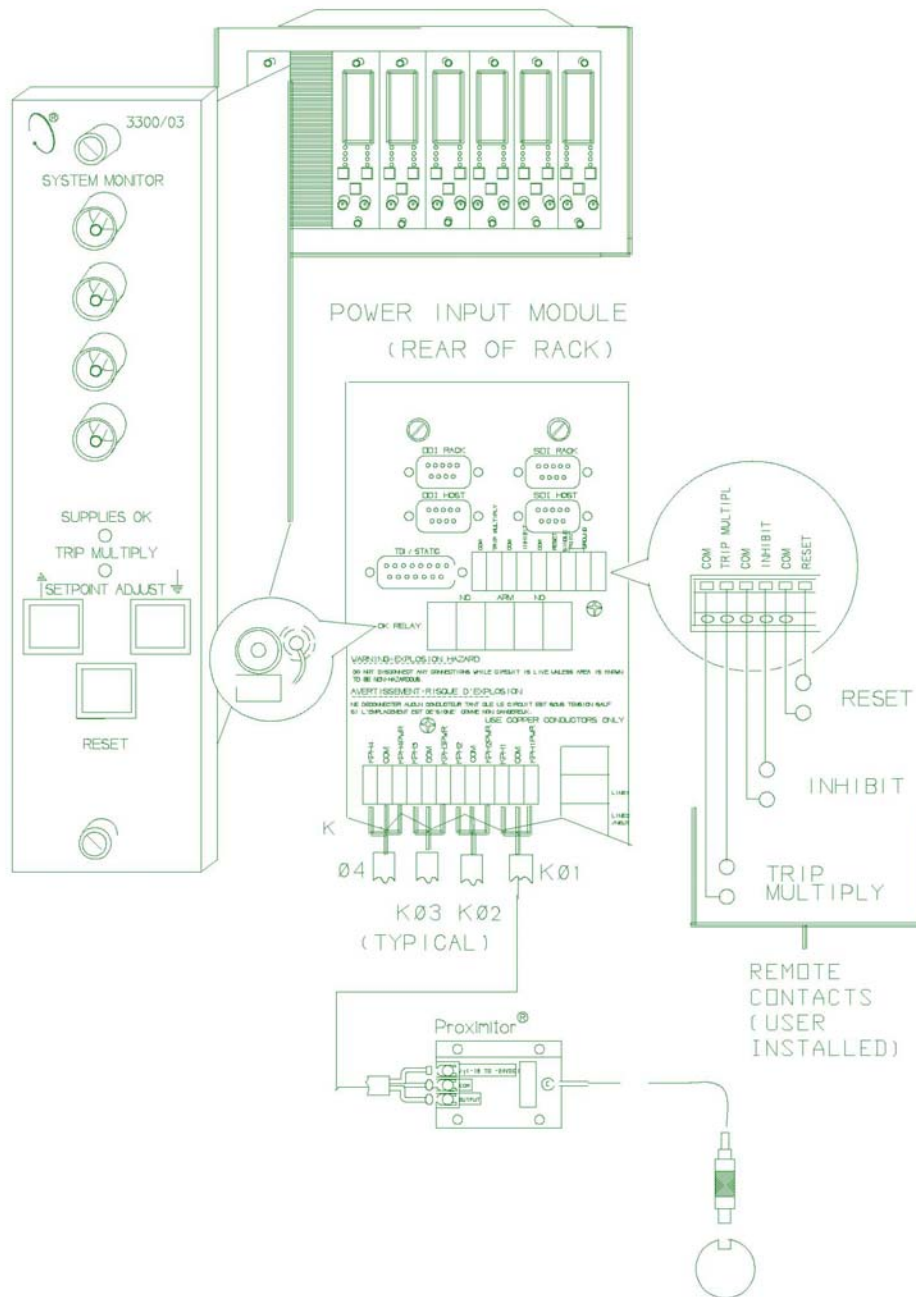

2. MONITOR FUNCTIONS

SYSTEM POWER-UP INHIBIT

The System Monitor provides a Power-up Inhibit function. This function allows each monitor to inhibit its alarms during power-up or whenever a system supply voltage falls below its operating level. After power-up, the inhibit function remains active for approximately 2 seconds.

RACK INHIBIT

When activated by an external contact closure this function places all monitors in bypass, disables all alarms, zero scales all outputs, and de-energizes the system OK relay. The connections for this function are located on the power input module (PIM) at the rear of the rack.

SUPPLY VOLTAGES OK

Seven LEDs located behind the front panel of the System Monitor are ON to indicate the voltage supplies are functioning. The voltage supplies are +VRH, +VRL, +7.5V, +5V, REF, -7.5V, and -VT. There is a green LED (SUPPLIES OK) on the front panel of the System Monitor. When this LED is on all of the voltage supplies are functional.

SYSTEM RESET

The System Monitor provides the ability to cause a System Reset. Closing external contacts through terminals on the PIM or pressing the RESET switch on the front panel will cause a System Reset.

TRIP MULTIPLY

The most common use of this function is to prevent unwanted monitor alarms during certain conditions of machine operation. In the operation of some machinery, it is impossible to avoid some periods of "higher than normal" vibration. Examples include startup and coastdown, especially if the operating speed is above rotor system balance resonances ("critical speeds"), structural and other resonances, and changes in machine load or other operating conditions.

The Trip Multiply function causes the monitor alarm setpoints (both Alert and Danger) to increase by a fixed amount, either two times (2X) or three times (3X), according to the ordering option. Only those monitors ordered with this option will be affected. The Trip Multiply function is performed in the System Monitor, but is an ordering option for each monitor. It must be specified at the time of order placement and be installed at the factory.

Trip Multiply is activated by contact closure on the PIM. A red LED on the System Monitor front panel indicates that the Trip Multiply function is active.

OK RELAY

The purpose of this relay is to provide a means to annunciate a problem that is detected with any transducer system connected to the rack. The OK Relay is connected to the OK Circuit of every

monitor in the rack. The OK Circuit continuously checks the condition of the transducer(s) associated with that monitor. If the circuit detects a transducer problem, the OK LED on the front of the affected monitor goes off and a relay drive signal is sent to the OK Relay in the System Monitor.

The OK Relay is located on the System Monitor PIM, is normally energized, and is a single-pole, double-throw (SPDT) relay. Since it is normally energized, the relay also can be used to annunciate when mains power to the rack is lost or interrupted. Either a system power-up inhibit signal from the System Monitor or a not OK signal from any monitor in the rack will cause the OK Relay to change state.

ALARM SETPOINT ADJUST

The System Monitor has two switches on the front panel that adjust alarm setpoint levels on each monitor. One switch is for upscale adjustments, and the other switch is for downscale adjustments.

DATA INTERFACE

The System Monitor supports the following Bently Nevada data interfaces: Dynamic Data Manager (DDM), Transient Data Manager® (TDM), Serial Data Interface (SDI), Dynamic Data Interface (DDI) and Transient Data Interface (TDI). The SDI and DDI are options of the System Monitor and reside within the System Monitor slot of the rack. DDM, TDM and TDI are external data interfaces which gain access to the rack through the PIM. There is an external version of the SDI and DDI which connects to the PIM. For more information about these products consult a Bently Nevada sales representative.

Keyphasor® TRANSDUCERS

The System Monitor receives input from four Keyphasor® transducers through terminals on the PIM. Two of the Keyphasor® transducers are available to the monitors within the rack. All four of the Keyphasor® transducers are available to the Dynamic Data Interface (DDI). Buffered Keyphasor® signals are also available from the coaxial connectors on the front panel. The System Monitor also provides short-circuit protected Keyphasor® transducer power.

STATIC DATA BUS BUFFER

The System Monitor multiplexes signals from either the DDM or TDM to select static data from the monitors. The System Monitor buffers the static data signals sent from the monitor to the DDM or TDM.

3. ASSEMBLY & DISASSEMBLY PROCEDURE

This section explains how to disassemble the System Monitor to set jumper options on the circuit board. To install a System Monitor to a rack set the options as described in section 7 then do steps 1 through 4 in reverse order. The only tool you need is a screwdriver.

1. Loosen the screws on the front panel and pull the System Monitor out from the rack.

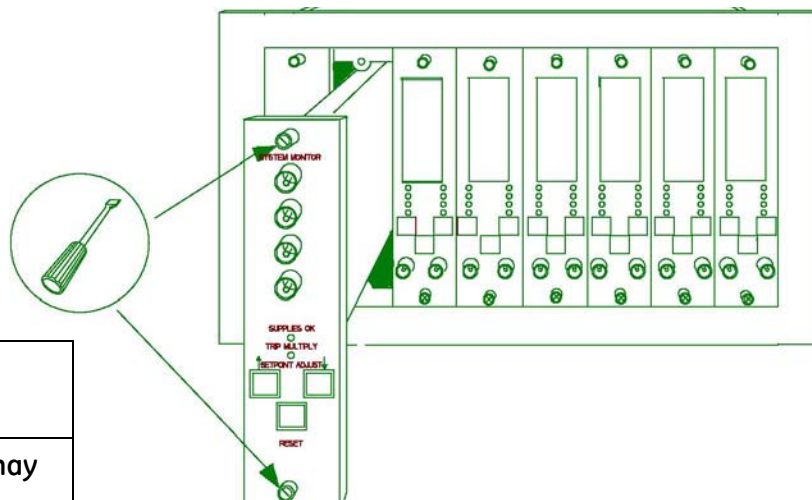

CAUTION

Improper rack operation may occur.
Power down rack when installing or removing a monitor.

2. Remove the side cover by pinching the protruding tip on each of the 4 standoffs.

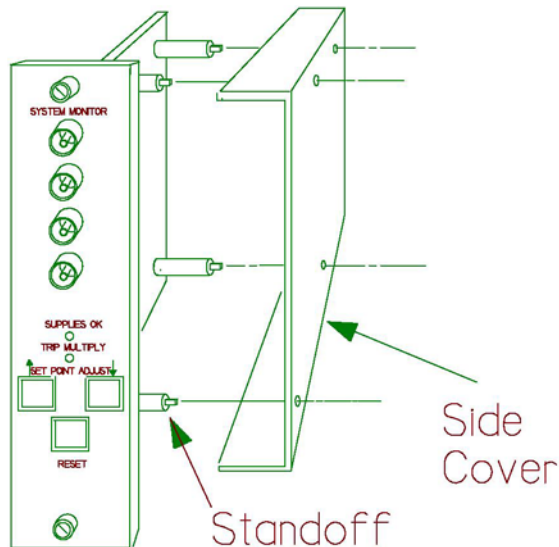

4. DATA INTERFACE REMOVAL

If the System Monitor has either the optional Dynamic Data Interface and or Serial Data Interface circuit boards installed, remove the data interface boards to access the option jumpers located on the System Monitor.

1. Remove the Dynamic Data Interface board by pinching the protruding tip on each of the 4 standoffs and gently prying the Dynamic Data Interface board away from the Serial Data Interface board.

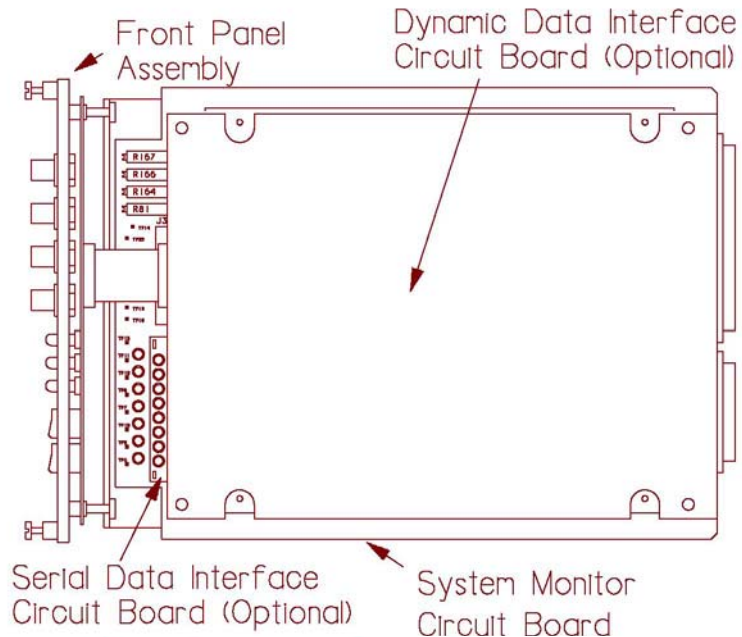

2. Remove the Serial Data Interface board by gently prying it away from the two mating connectors and 5 standoffs on the System Monitor board.

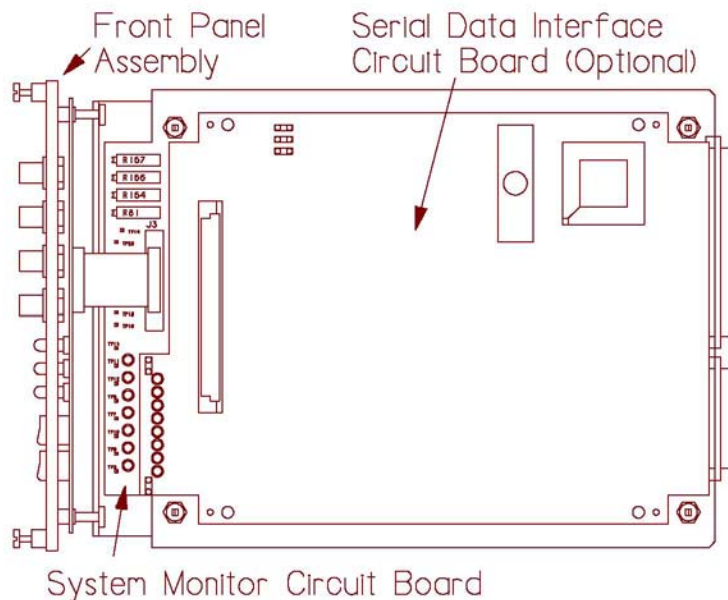

5. FRONT PANEL INSTALLATION & REMOVAL

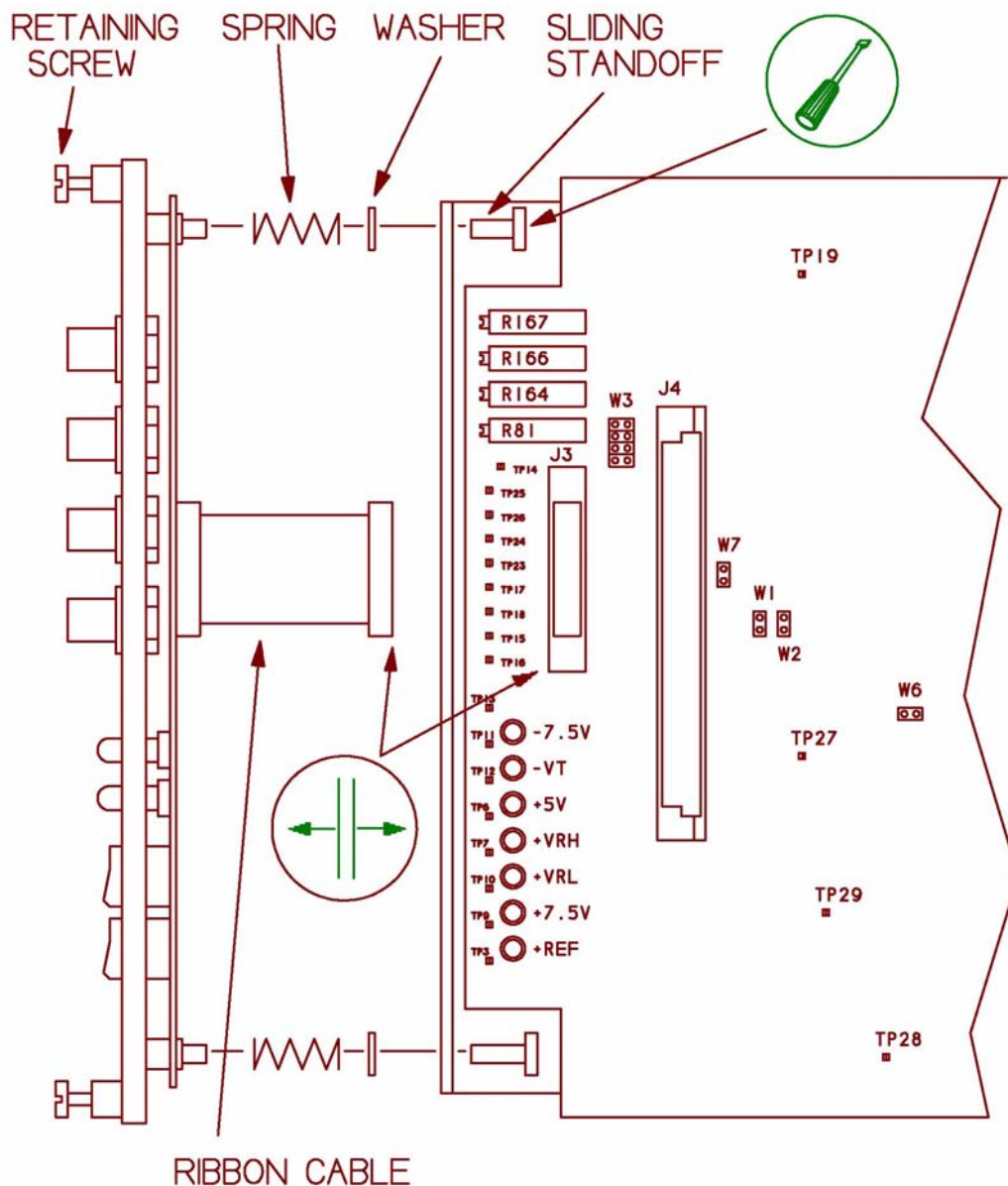

6. MONITOR OPTIONS

SYSTEM MONITOR

PART NUMBER

DATA INTERFACE

AGENCY APPROVAL

3300/03

AXX

BXX

01 = None or DDM/TDM	00 = NOT REQUIRED
02 = SDI	01 = CSA
03 = DDI	02 = BASEEFA
	03 = FM

7. PROGRAMMABLE OPTIONS

The System Monitor has jumper-programmable options for selecting the transducer voltage and the data interface. Change these options by removing and installing jumpers on the circuit board.

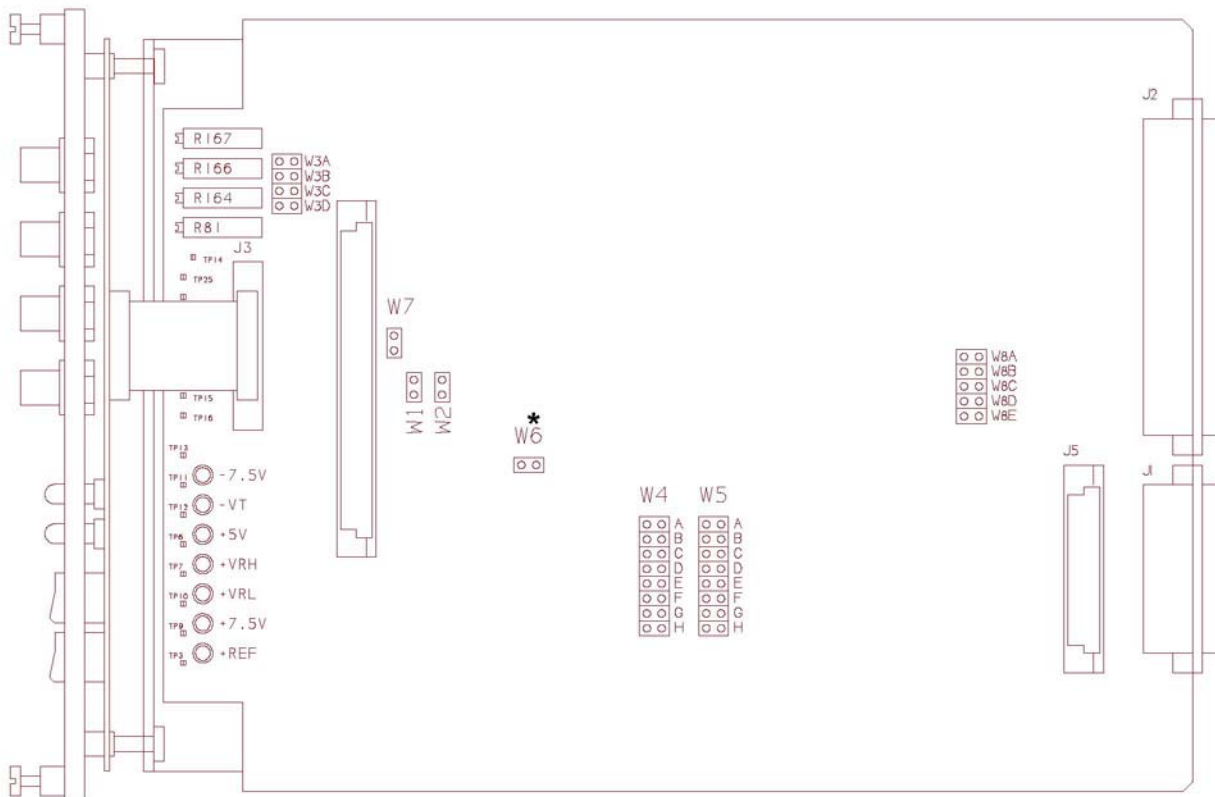

Jumper Locations

* W6 is for future use or is N/A.

Data Manager Options

To configure the System Monitor to work with the different data interfaces remove all option jumpers from headers W3A-W3D, W4A-W4H, W5A-W5H, W7 and W8A-W8E and install jumpers as specified in Table 1.

Table 1. Data Manager Options

OPTION	INSTALL JUMPERS
Dynamic Data Manager® or Transient Data Manager® or No Data Interface	W3A,W3B,W5A,W5B,W5C,W5D,W5E,* W5F,W5G,W5H,W8D & W8E
Internal Serial Data Interface/ Dynamic Data Interface	W3C,W3D,W4A,W4B,W4C,W4D,W4E,** W4F,W4G,W4H,W7,W8D & W8E
External Serial Data Interface/ Dynamic Data Interface or Transient Data Interface	W3C,W3D,W5A,W5B,W5C,W5D,W5F, W5G,W5H,W8A,W8B & W8C

* As shipped from factory for a 3300/03 - 01 System Monitor.

** As shipped from factory for a 3300/03 - 02 or 3300/03 - 03 System Monitor.

-VT Options

To set the -VT option according to the option set on the Power Supply, remove jumpers from headers W1 and W2 and install jumpers as specified in Table 2.

Table 2. -VT Options

OPTION	INSTALL JUMPER	REMOVE JUMPER
-VT = -18 Volts	W2	W1
-VT = -24 Volts	W1	W2

8. OK RELAY CONFIGURATION

The following diagram shows the functional concept of the OK Relay. For more detail refer to schematics (see Section 13).

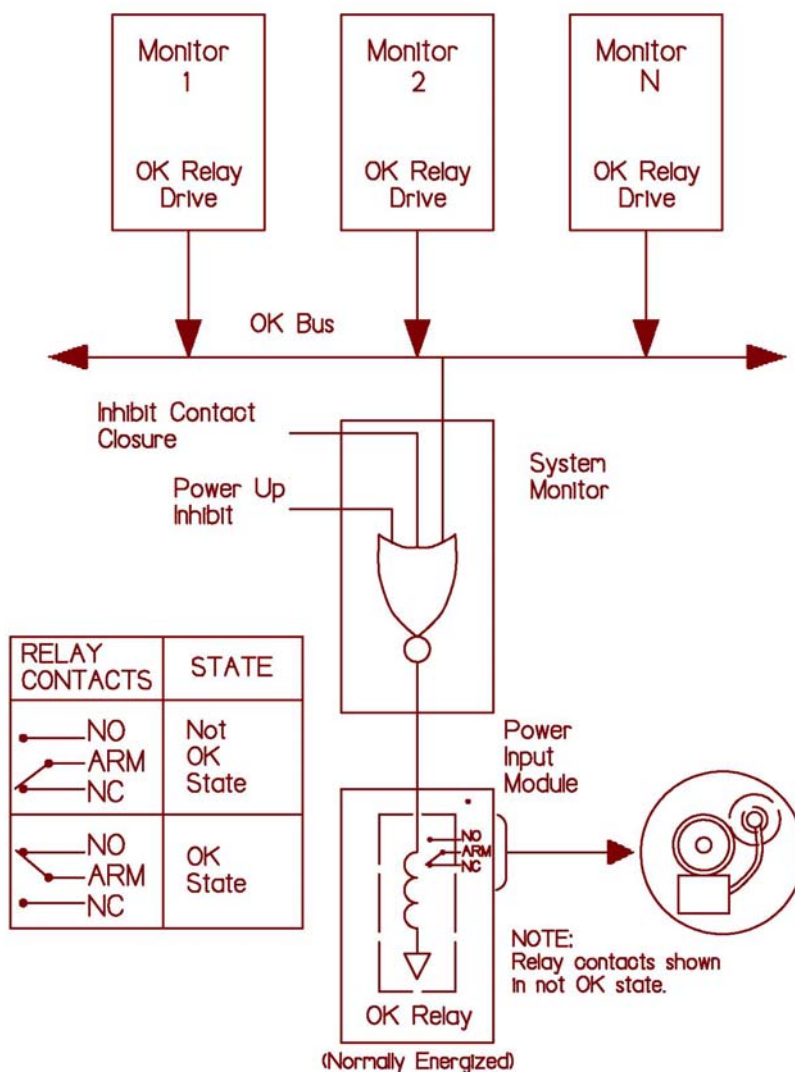

9. OPERATIONAL TESTING

To verify that the system monitor is functional apply power at the Power Input Module. The LED indicating that the supplies are OK should turn on after 2 seconds.

CAUTION
 Improper operation may occur. Set -VT Jumpers in the System Monitor and Power Supply to the same voltage (-18 VDC or -24 VDC).

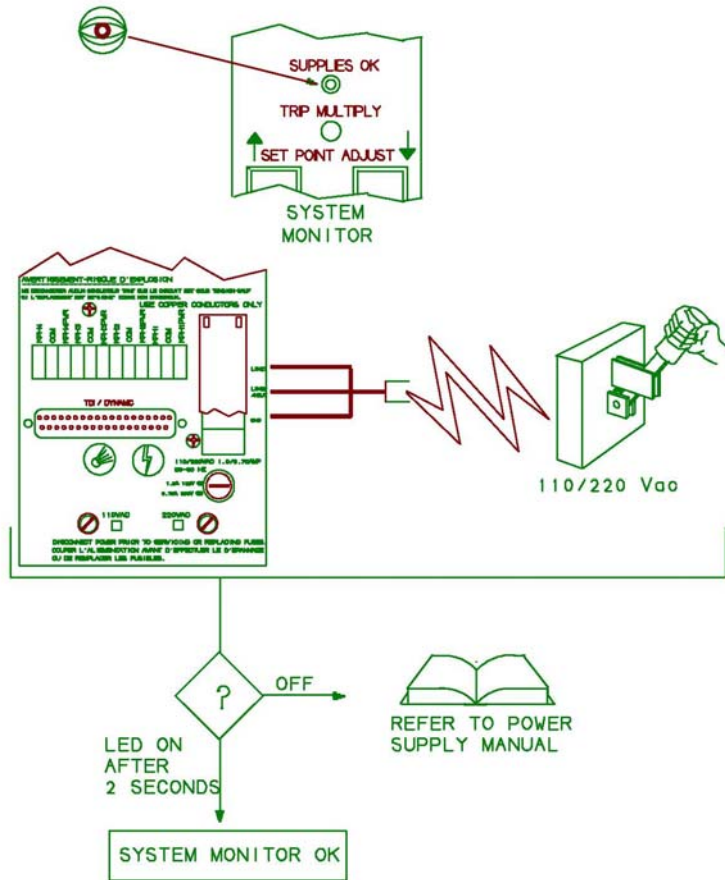

10. Keyphasor OPERATIONAL TEST

The following test procedure for Keyphasor® transducer 1 is also applicable for testing Keyphasor® transducers 2 through 4.

The machine associated with the Keyphasor® transducer under test should be running during this procedure. If the machine is not turning, simulate the operating machinery input at approximately the same frequency as the shaft rotating speed, with a function generator or TK3 test kit.

1. Measure Keyphasor® 1 power at the **KPH1PWR** terminal on the power input module (PIM). If -VT is -24 V, the voltage should read between -23.2 and -24.2 Vdc. If -VT is -18 V, the voltage should read between -17.40 and -18.30 Vdc.

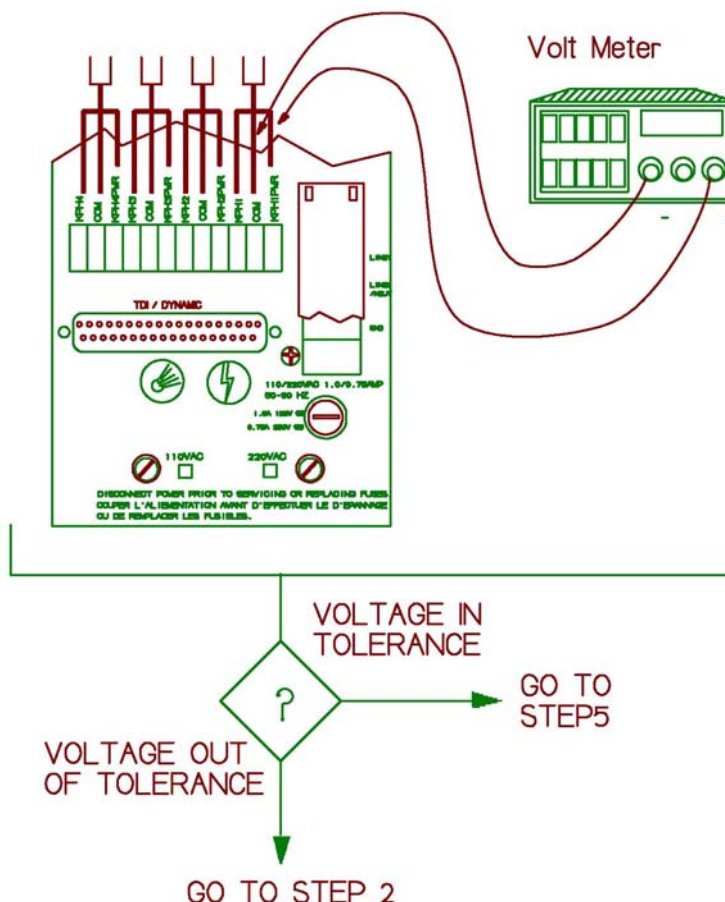

2. Disconnect the wire from the **KPH1PWR** terminal and measure the voltage at the power terminal. The voltage should be within the tolerance specified in step 1.

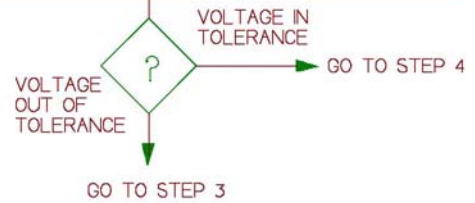
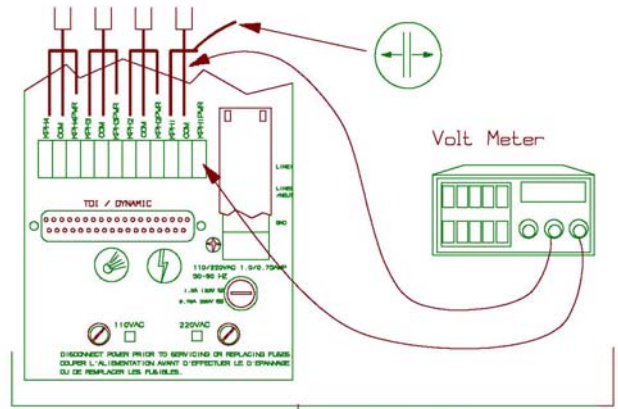

WARNING
High voltage present. Contact could cause shock, burns, or death.

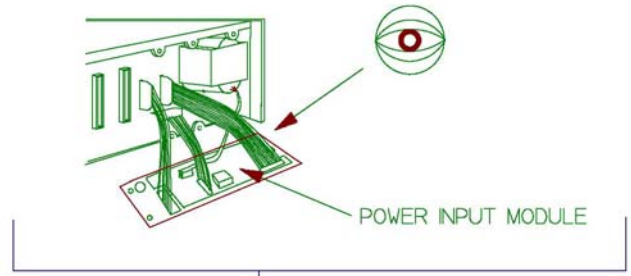

3. Loosen the screws that hold the power input module to the rack and pull the power input module out from the rear of the rack. Examine the cabling and connections between the module and the rack.

4. Reconnect the wire to the **KPH1PWR** tern Disconnect the wire at the **-VT (-18 or -24 Vd** terminal of the Proximitor®. Measure the voltage the wire. The voltage should be within the tole specified in step 1.

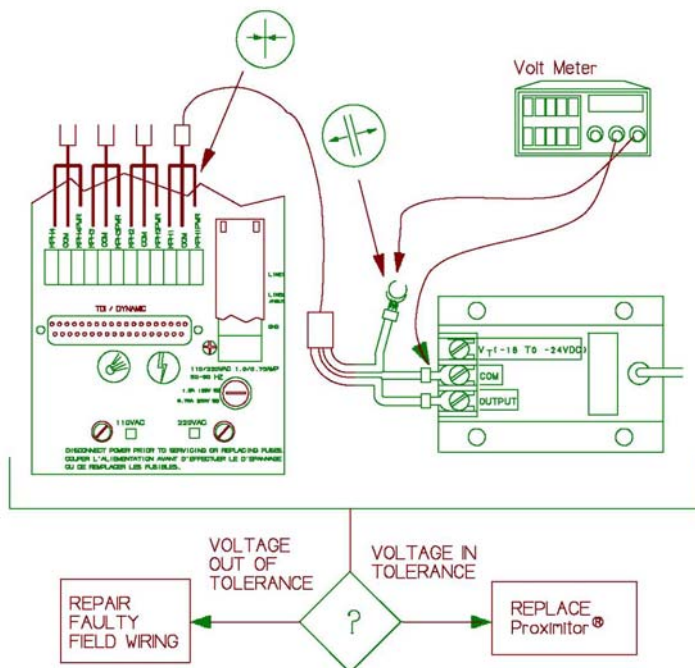

5. Check the Keyphasor® output signal at the System Monitor front panel **KO / 1** coaxial conne

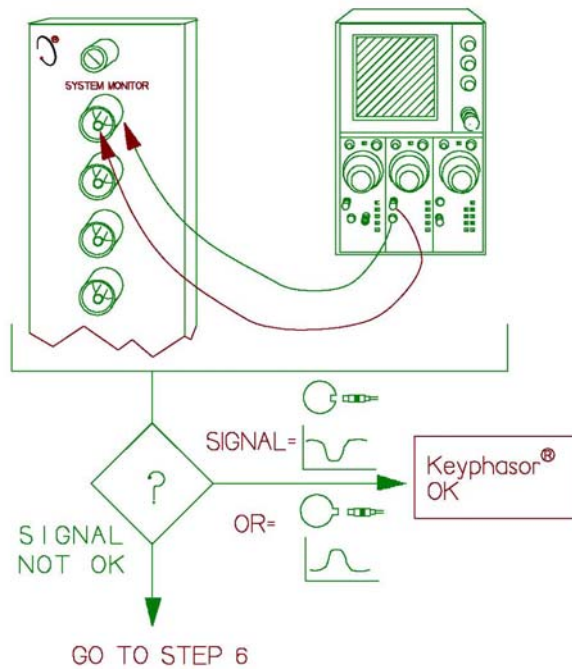

6. Check Keyphasor® signal at the power input module **KPH1** terminal.

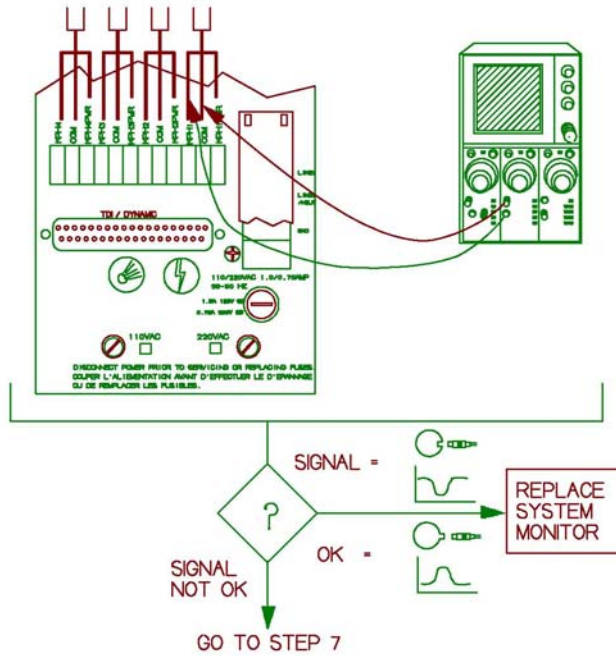

7. Disconnect wire at the power input module **KPH1** terminal and check wire for Keyphasor® signal.

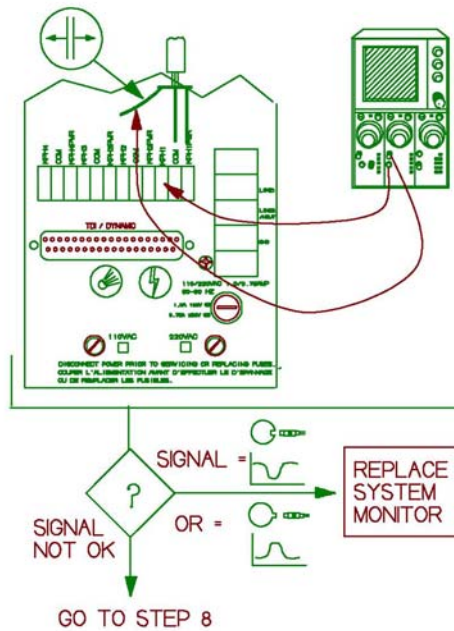

8. Reconnect wire to the power input module **KPH1** terminal.

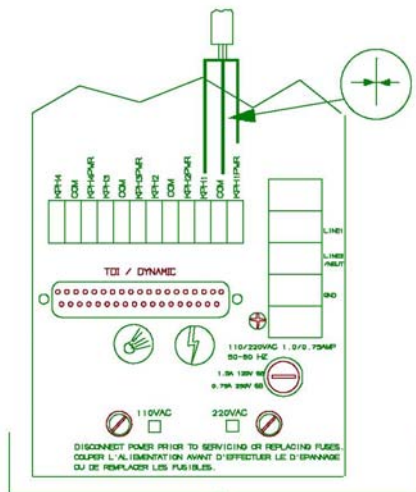

GO TO STEP 9

9. Disconnect wire at the Proximito[®] output terminal and check signal at the output terminal.

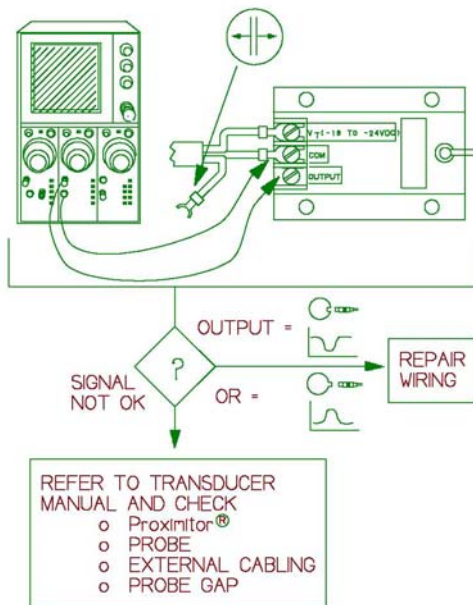

11. RECOMMENDED SPARE PARTS

Table 3. Spare Part Listing

QTY	DESCRIPTION	PART NUMBER
1	Front Panel Assembly 3300/03-01	87900-02*
	3300/03-02	87900-01*
	3300/03-03	87900-01*
1	Monitor Circuit Assembly	87890-01*
1	Spare Jumpers (100 pieces)	88706-01

TO ORDER REPLACEMENT PARTS, SPECIFY THE COMPLETE CATALOG NUMBER, 3300/03 – AXX - BXX, AND THE REPLACEMENT PART NUMBER.

If the monitor has been modified, specify the modification number on the parts order. You must set the programmable options. Section 7 lists how the options are set at the factory. If in doubt about the part number, call your Bently Nevada Corporation representative before ordering.

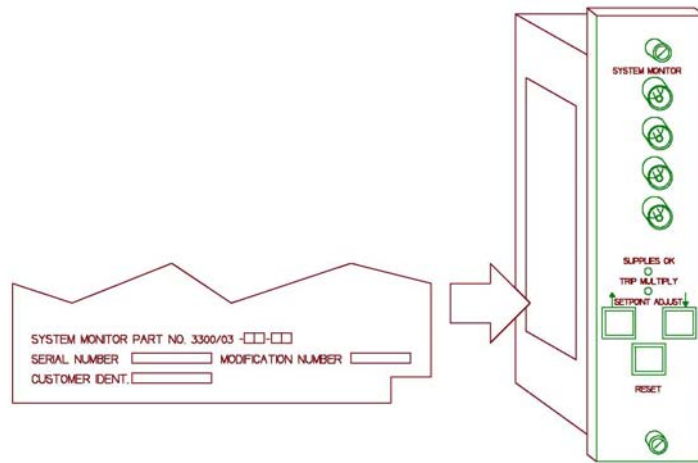

MONITOR IDENTIFICATION LABEL

12. SPECIFICATIONS

INPUTS

No external loads, normal operation mode, 25°C

Supply	Voltage
+VRH:	23.65 ± 6.35 Vdc
+VRL:	11.22 ± 3.09 Vdc
+7.5V:	7.5 ± 0.1 Vdc
+5V:	5.00 ± 0.05 Vdc
REF:	5.00 ± 0.009 Vdc
-7.5V:	-7.5 ± 0.1 Vdc
-VT (-24V Option):	-23.75 ± 0.45 Vdc
-VT (-18V Option):	-17.9 ± 0.4 Vdc

SYSTEM POWER-UP INHIBIT

Delay: 2.1 ± 1 seconds

CONTACT CLOSURE RATING

Contacts for System Reset, Inhibit, OK, and Trip Multiply

Active: < 100 Ω

Keyphasor®

Output Voltage

-24V Option: -23.2 V to -24.2 V, Short-circuit Protected

-18V Option: -17.4 V to -18.3 V, Short-circuit Protected

ENVIRONMENTAL

Temperature: Operating: +32° F to +149° F (0° C to +65° C).

Storage: -40° F to +185° F (-40° C to +85° C).

Humidity: 0 to 95%, noncondensing.